

The DEHN logo is positioned in the upper right corner of the top image. It consists of the word "DEHN" in a bold, white, sans-serif font, flanked by two white chevron-like shapes pointing outwards.

Lightning and surge protection for battery storage systems

White Paper



Contents

Danger in storms

Damage to battery storage systems

What does the standard say?

Causes of transient overvoltages

PV storage systems (Metal container with air-termination tips)

Battery storage systems for the power grid (Concrete container with HVI lightning protection)

Selection of lightning and surge protective devices

Lightning and surge protection for battery storage systems

White Paper



Danger in storms

Several billion lightning flashes come down in the world each year. In Germany alone, more than 2 million lightning events are recorded annually and the tendency is rising. If lightning strikes in the direct vicinity, it damages buildings and the infrastructure: lightning strikes can cause fires or surge damage to electrical devices and systems. The latter also applies to lightning strikes up to 2 km away. The switching of a battery storage system or of a transformer in the grid may cause switching overvoltages and damage. It often takes only very small surges to damage electronic equipment.

Damage to battery storage systems

Power storage systems are one of the key technologies of the energy revolution as they make it possible to store locally produced electricity on site. The container battery storage systems store the power generated, e.g., by photovoltaic systems and wind turbines, and feed it back on demand. Thanks to decentral storage, they also reinforce network stability and can be used by the network operator to provide balanced power. The constantly increasing proportion of renewable energies leads to an increase in the number of grid-connected storage systems required. Correspondingly, this increases the efficiency of renewable energies. The implementation of inverters with mains filters improves the voltage quality. In addition, battery storage for the power grid forms the basis for energy management (so-called "peak shaving").

In order to provide optimum protection for the high-end electronics in storage containers, one needs a comprehensive light-

ning and surge protection system. Even more so, in view of the fact that the installation location and the operating conditions may vary considerably due to the mobile nature of the containers and their planned worldwide installation. The greatest danger for battery storage systems is lightning discharge. The resulting overvoltage far exceeds the dielectric strength of the electronic components in the storage system. In addition, network-related voltage peaks, e.g., from switching operations or earth and short circuits must be considered a potential threat. The result is defective electronic components, e.g., information and communication technology and defective inverters or battery units. In the case of a direct strike, the metal roof may also be perforated resulting in water damage when it rains.

The constant availability of these storage systems is also a key issue. As damage leads to serious economic consequences and expensive maintenance and repair work, it is important to make provisions for a reliable lightning and surge protection concept.

What does the standard say?

The standard series IEC 60364 comprises installation standards and is therefore applicable to fixed installations. Permanently wired, non-mobile battery storage systems fall under the scope of IEC 60364.

IEC 60364-4-44 deals with the protection of electrical systems in case of transient overvoltages resulting from atmospheric influences transmitted via the supply network, including direct lightning strikes in the supply lines and transient overvoltages caused by switching operations.

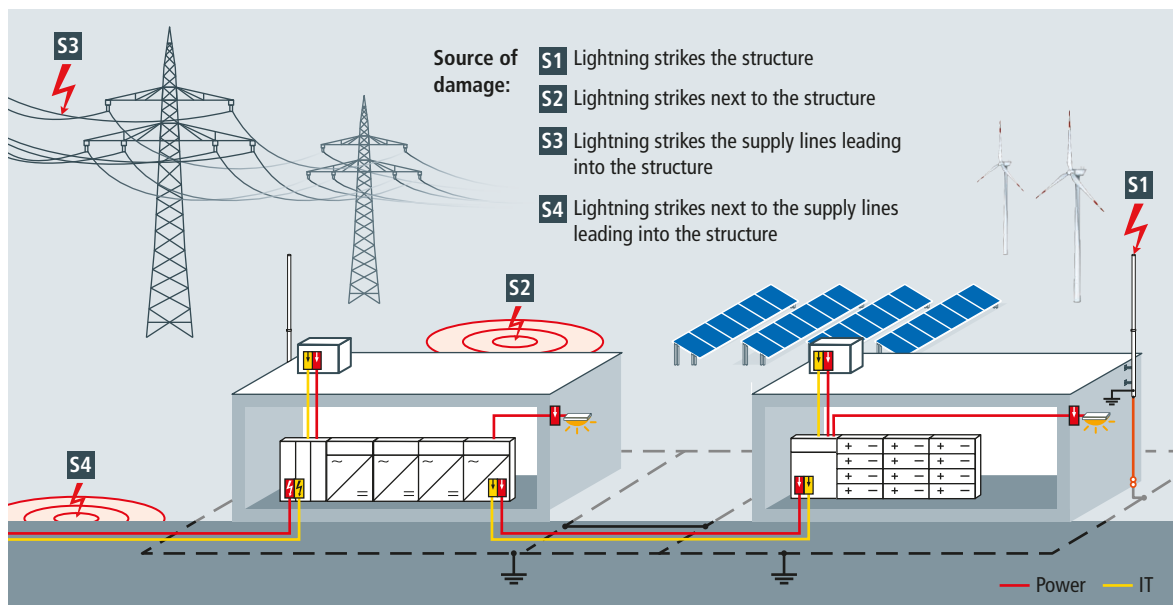

Figure 1 Causes of overvoltages

Lightning and surge protection for battery storage systems

White Paper



It provides conclusions as to whether surge protective measures are required, assesses the risk of the location, defines surge protection categories and the correspondingly required rated impulse withstand voltage levels of the equipment, and defines whether additional surge protective devices are necessary. It also considers the required availability of the system.

A risk analysis according to IEC 62305-2 is carried out to determine which external lightning protection measures are required, for example, which class of LPS needs to be considered in the planning and implemented in the lightning protection concept. If, for example, the risk analysis reveals the necessity for a lightning protection system of class 3 of LPS, IEC 62305-3 must be followed.

The German rule of application VDE-AR-E 2510-2 "Stationary battery energy storage systems for connection to the low-voltage network" also stipulates that provisions should be made for lightning and surge protection measures in the connection concept. If lightning and surge protection measures are implemented in compliance with IEC 60364-4-44 and IEC 62305, they should be installed in accordance with IEC 60364-5-53.

Causes of transient overvoltages

A direct strike in the battery energy storage system or in the supply line is characterised by lightning current with the impulse waveform 10/350 μ s. Distant lightning strikes or so-called indirect lightning strikes lead to conducted partial lightning currents (impulse waveform 10/350 μ s) in the supply lines, or also to induced / capacitive couplings (impulse 8/20 μ s) in the electronic components of the storage system itself (so-

called LEMP = Lightning ElectroMagnetic Pulse) (Figure 1). In addition, overvoltages can be caused by switching operations, earth and short circuits or the tripping of fuses (so-called SEMP = Switching ElectroMagnetic Pulse).

PV storage systems (Metal container with air-termination tips)

If PV power stations are equipped with a battery storage system, the electronic equipment, battery and inverter need to be protected against surges.

Figure 2 shows a PV storage system (container construction) which discharges the direct lightning strike to the soil via the metal housing of the container. To prevent a direct strike from melting holes in the metal roof, the four corners are fitted with air-termination tips as defined strike points. The earthing system illustrated consists of a 30 x 3.5 mm flat strip or, alternatively, a round wire with a diameter of 10 mm.

To ensure the durability and functionality of the earthing system, it is advisable to use a permanently corrosion resistant material such as stainless steel V4A (1.4404). This safeguards personal safety and the discharge of lightning currents to the earth for many years to come. The equipment inside the container is protected in a similar way to a Faraday cage, i.e., the separation distances to the electrical components inside must be kept. Suitable lightning current and surge arresters should be installed as closely as possible to where the mains supply lines enter the container in order to discharge any interference impulse coupling via these copper-based lines. We recommend the use of a protective device from the DEHNventil

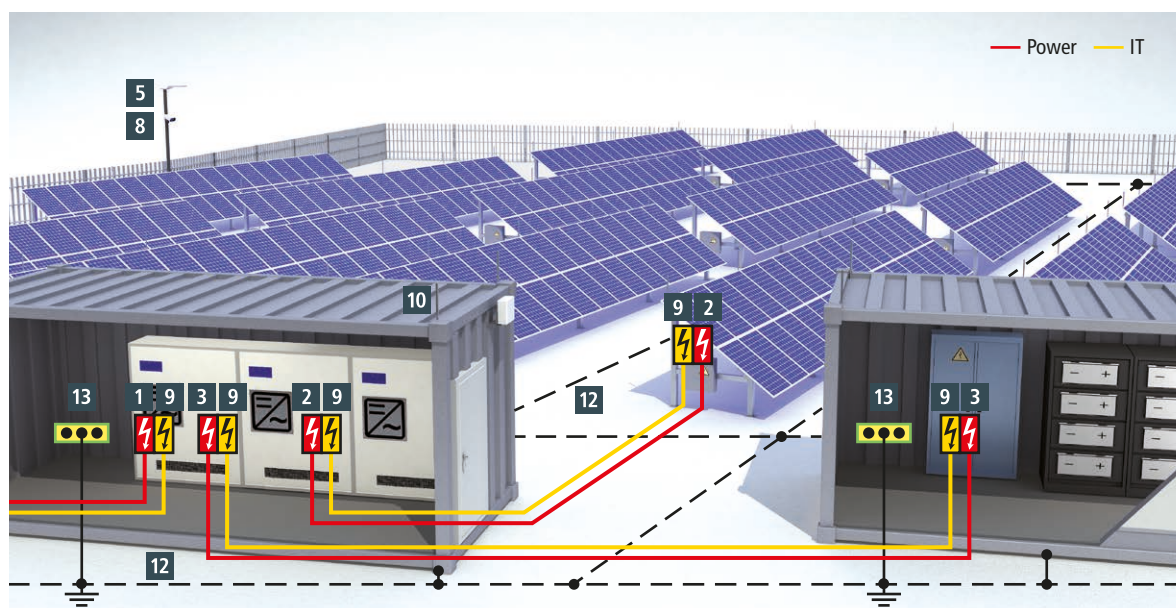

Figure 2 PV battery storage system as a metal construction

Lightning and surge protection for battery storage systems

White Paper

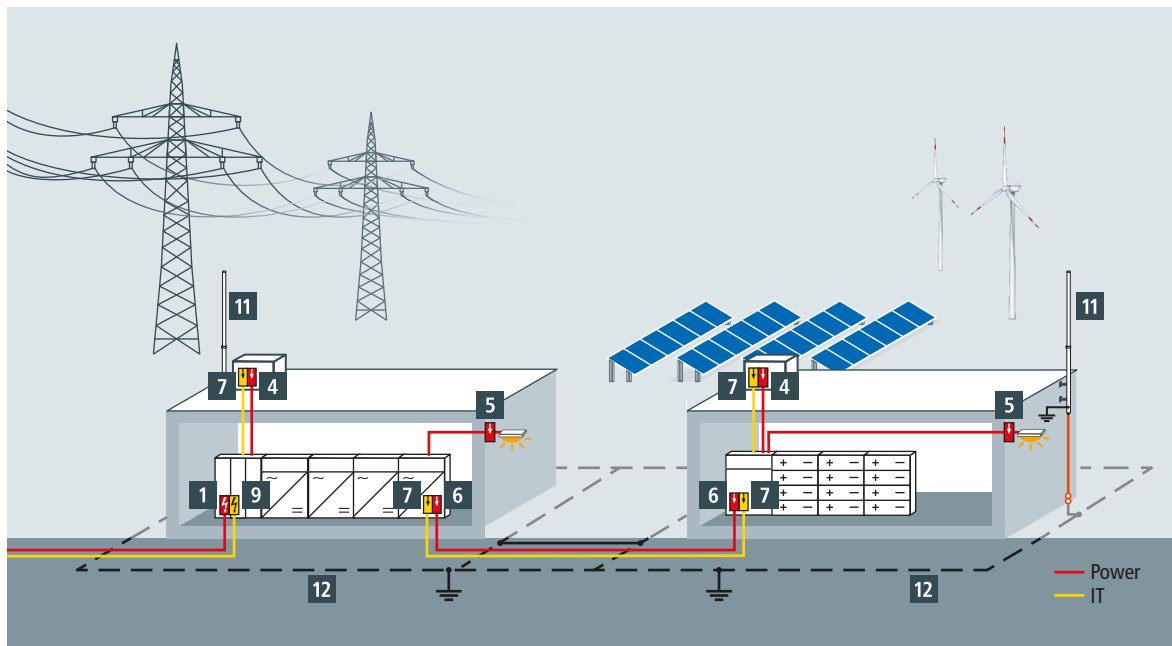

Figure 3 Battery storage system for power grid as a concrete construction with HVI Lightning protection

	No.	Type	Part No.	Other	
Type 1 + 2 combined surge arrester 230/400V (50 Hz)	1	DEHNventil M2	DV M2 TT 255 FM	954 315	Modular combined lightning current and surge arrester for TT and TN systems with a nominal voltage of 230/400V (3+1 configuration)
Combined arrester type 1 + 2, DC applications	2	DEHNcombo YPV	DCB YPV 1500 FM	900 076	Combined lightning current and surge arrester for use in battery storage and power supply systems up to 1500 V DC, with backup fuse up to an I_{sccr} of 50kA
Combined arrester type 1 + 2, DC applications	3	DEHNguard	DG ME DC Y 950 FM	972 146	DC current characteristics up to 950 V and a backup fuse up to 50 kA I_{sccr} , with powerful DC switching device DCD
Type 2 + 3 surge arrester	4	DEHNguard modular	DG M TT 275 FM	952 315	For TT and TN systems with 230/400 V nominal voltage (3+1 configuration)
	5	DEHNcord	DCOR L 2P 275 SO IP	900 448	Universal surge arrester with IP 65 design for outdoor use, e.g., LED lighting
Type 2 + 3 surge arrester DC application (battery)	6	DEHNguard SE DC	DG SE DC 900 FM	972 145	DC current characteristics up to 950 V, with powerful DC switching device DCD
		<i>alternatively:</i> DEHNguard modular YPV	DG M YPV 1500 FM	952 567	For DC current characteristics up to 1500 V and tested with backup fuse up to 50 kA I_{sccr}

Table 1a Selection guide for the protection of battery storage systems – part 1

Lightning and surge protection for battery storage systems

White Paper



family to protect the 230/400 V supply line. This is a prewired, modular type 1 and 2 combined lightning current and surge arrester, based purely on spark gap technology with a discharge capacity of up to 100 kA (10/350 μ s) which reliably protects terminal devices due to its excellent protection level and en-

ergy absorbing capacity. The type 1 combined arrester family, BLITZDUCTOR XT, is suitable for wired data interfaces, e.g., RS 485 interfaces. The integrated LifeCheck monitoring technology enables the implementation of a predictive maintenance concept. The relevant signal statuses can be communicated via

	No.	Type	Part No.	Other	
Data and Communication lines *	7	BLITZDUCTORconnect	BCO ML2 BD HF 24	927 275	e.g., for bus systems
		<i>alternatively:</i> DEHNpatch	DPA CL8 EA 4PPOE	929 161	e.g., Industrial Ethernet, Power over Ethernet
		<i>alternatively:</i> DEHNgate	DGA G SMA	929 039	Universal combined arrester for coaxial connections with SMA technology
	8	DEHNpatch outdoor	DPA CLE IP66	929 221	For outdoor applications, e.g., surveillance cameras, PoE++ / 4PoE
	9	BLITZDUCTORconnect	BCO ML2 B 180	927 210	e.g., for RS485 or XDSL DIN rail mounted devices with integrated LifeCheck function
External lightning protection	10	Air-termination rod 1000 mm with connection lugs and clamping frame	FS 10 1000 AL + AL ZF KB 6.10STTZN B5.2 6.5 L81 AL	101 000 +377 100	
	11	HVI light conductor inside supporting tube with air-termination rod and fastening fixtures	HVI LI 20 L6M SR1990 FSP1000 GFK	819 256	
Earthing material	12	Strip StSt V2A, 30 mm x 3.5 mm	BA 30X3.5 V2A R60M	860 900	Stainless steel strip
		<i>alternatively:</i> Round wire StSt V4A, Rd. 10 mm	RD 10 V4A R80M	860 010	
Equipotential bonding	13	K12 equipotential bonding bar	PAS 11AK	563 200	For protective and functional equipotential bonding and lightning equipotential bonding
Accessories		IRCM adaptor for DEHNpatch	DPA MOD IRCM	929 309	Remote monitoring through optional module attachment and DRC IRCM remote signalling unit
		Condition Monitoring Unit for DEHNrecord	DRC IRCM	910 710	Condition monitoring unit DEHNrecord, set for DIN rail mounted devices with integrated visual transmitter / receiver and visual reverse unit for monitoring the condition of BCO arresters with LifeCheck. Visual arrester status indication via LED group display in combination with remote signalling contact

*Selection depending on the interface

Table 1b Selection guide for the protection of battery storage systems – part 2

Lightning and surge protection for battery storage systems

White Paper



Modbus TCP/RTU using floating remote signalling contacts, RS 485 interfaces or DEHNrecord Alert. Further information and communication interfaces like Ethernet are reliably protected by DEHNpatch, and coaxial antenna interfaces by DEHNgate. The connection lines between the battery and the DC outputs of the inverter must be protected by a type 1 SPD because they cross different lightning protection zones. The type 1 + 2 combined arrester DG ME DC Y 950 FM for use up to a direct current of 950 V is an excellent choice here. The type 1 + 2 combined arrester DCB YPV 1500 FM is suitable for direct currents up to 1500 V DC.

When fitted with air-termination devices, the DC connection lines of a PV module must be protected by a type 1 surge arrester especially designed for use in photovoltaic systems, such as the DEHNcombo YPV type 1 + 2 combined lightning current and surge arrester with no need for a backup fuse. DEHNpatch outdoor provides protection for external monitoring units, like cameras with PoE connections. If, in addition, the solar park is lit with LED lighting, this should also be protected against the effects of surges and wear and tear from switching operations using DEHNcord. The equipotential bonding required in the standard is achieved with a K12 equipotential bonding bar. These busbars are specially tested for application as protective and functional equipotential bonding according to IEC 60364-4-41 / 60364-5-54 and lightning equipotential bonding to IEC 62305-3

Battery storage systems for the power grid (Concrete container with HVI lightning protection)

If battery storage systems for the power grid have a concrete construction (Figure 3), is often impossible, or at least very difficult, to maintain separation distances to the external lightning protection system. This problem can be solved by installing high-voltage resistant insulated conductors, so-called HVI conductors. In this way, one can prevent dangerous flashover from the external lightning protection system to conductive parts such as supply lines. If the batteries and

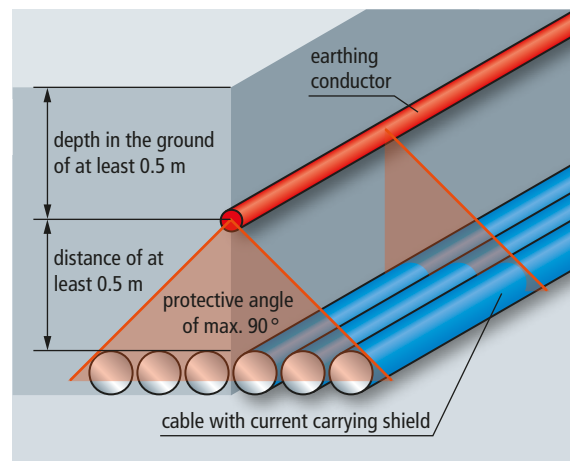

Figure 4 Protected volume for cable route

inverters are in separate containers, in the event of direct and nearby lightning strikes galvanic lightning currents are coupled in the connecting cables. To prevent this from happening, an earthing conductor must be laid above the cables to include them in the protected volume (Figure 4). It is therefore enough to connect the cables on both sides to type 2 surge arresters, e.g., DEHNguard SE DC. These are specially constructed for application in DC circuits and include a high-capacity DC switching device DCD to prevent fire damage due to DC switching arcs.

Selection of lightning and surge protective devices

When selecting appropriate lightning current and surge protective devices, many things play an important role in addition to details about the location: information on the local system configuration, the system voltage and the nominal current of the relevant interfaces. A possible selection can be seen in Table 1.

DEHNguard ME

DG ME DC Y 950 FM (972 146)

- Powerful d.c. switching device DCD



Figure without obligation

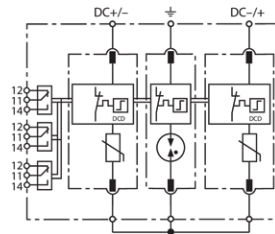

Basic circuit diagram DG ME DC Y 950 FM

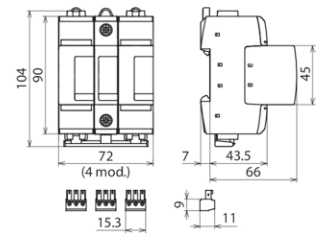

Dimension drawing DG ME DC Y 950 FM

Modular combined lightning current and surge arrester for d.c. applications; with floating remote signalling contact.

Type Part No.	DG ME DC Y 950 FM 972 146
SPD analogous to EN 61643-11 / IEC 61643-11	type 1 + type 2 / class I + class II
Nominal voltage (d.c.) (U_N)	860 V
Max. continuous operating voltage (d.c.) (U_C)	950 V
Lightning impulse current (10/350 μ s) (I_{imp})	5 kA
Nominal discharge current (8/20 μ s) (I_n)	12.5 kA
Voltage protection level [DC+ \rightarrow DC-] (U_P)	≤ 4 kV
Voltage protection level [(DC+/DC-) \rightarrow PE] (U_P)	≤ 3.2 kV
Max. short circuit withstand capability (I_{SCCR})	500 A / 170 ms
Temporary overvoltage (TOV) [DC+ \rightarrow DC-] (U_T) – Characteristic	950 V ($U_{TOV} = U_C$)
Temporary overvoltage (TOV) [DC+/- \rightarrow PE] (U_T) – Characteristic	950 V / 10 sec. – withstand
Operating temperature range (T_U)	-40 °C ... +80 °C
Operating state / fault indication	green / red
Number of ports	1
Cross-sectional area (min.)	1.5 mm ² solid / flexible
Cross-sectional area (max.)	35 mm ² stranded / 25 mm ² flexible
For mounting on	35 mm DIN rails acc. to EN 60715
Enclosure material	thermoplastic, red, UL 94 V-0
Place of installation	indoor installation
Degree of protection	IP20
Capacity	4 module(s), DIN 43880
Approvals	UL
Type of remote signalling contact	changeover contact
Switching capacity (a.c.)	250 V / 0.5 A
Switching capacity (d.c.)	250 V / 0.1 A; 125 V / 0.2 A; 75 V / 0.5 A
Cross-sectional area for remote signalling terminals	max. 1.5 mm ² solid / flexible
Extended technical data:	-----
– Residual voltage (U_{res}) @ 1.2 kA	2,5 kV
– Use in DC battery storage systems up to I_{SCCR}	≤ 50 kA ($t \leq 4$ ms)
– Backup fuse for DC battery storage systems up to I_{SCCR}	Bussman HLS 2000Vdc / 200 A 2+/A173 DST aR, manufacturer's Part No.: 170M2040
Weight	497 g
Customs tariff number (Comb. Nomenclature EU)	85363030
GTIN	4013364347960
PU	1 pc(s)

DEHNventil

DV M2 TT 255 FM (954 315)

- Prewired spark-gap-based type 1, type 2 and type 3 combined arrester consisting of a base part and plug-in protection modules
- Compact unit meets maximum safety requirements thanks to Rapid Arc Control (RAC)
- Capable of protecting terminal equipment



Figure without obligation

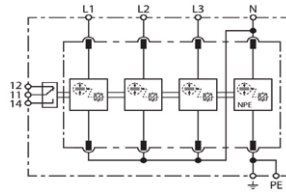

Basic circuit diagram DV M2 TT 255 FM

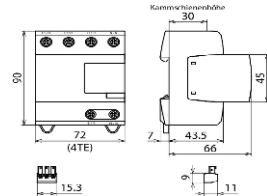

Dimension drawing DV M2 TT 255 FM

Modular combined lightning current and surge arrester for TT and TN-S systems (3+1 configuration).

Type	DV M2 TT 255 FM
Part No.	954 315
SPD according to EN 61643-11 / IEC 61643-11	type 1 + type 2 + type 3 / class I + class II + class III
Nominal voltage (a.c.) (U_N)	230 / 400 V (50 / 60 Hz)
Max. continuous operating voltage (a.c.) [L-N] (U_C)	255 V (50 / 60 Hz)
Max. continuous operating voltage (a.c.) [N-PE] ($U_{C(N-PE)}$)	255 V (50 / 60 Hz)
Lightning impulse current (10/350 μ s) [L1+L2+L3+N-PE] (I_{total})	100 kA
Specific energy [L1+L2+L3+N-PE] (W/R)	2.50 MJ/ohms
Lightning impulse current (10/350 μ s) [L-N]/[N-PE] (I_{imp})	25 / 100 kA
Specific energy [L-N]/[N-PE] (W/R)	156.25 kJ/ohms / 2.50 MJ/ohms
Nominal discharge current (8/20 μ s) [L-N]/[N-PE] (I_n)	25 / 100 kA
Voltage protection level [L-N]/[N-PE] (U_p)	≤ 1.5 / ≤ 1.5 kV
Open-circuit voltage of the combination wave generator (U_{oc})	6 kV
Follow current extinguishing capability [L-N]/[N-PE] (I_a)	50 kA _{rms} / 100 A _{rms}
Follow current limitation / Selectivity	No tripping of a 32 A gG fuse up to 50 kA _{rms} (prosp.)
Short-circuit current rating [L-N]/[N-PE] (I_{SCCR})	50 kA _{rms} / 100 A _{rms}
Response time (t_a)	≤ 100 ns
Max. backup fuse (L) up to $I_k = 50$ kA _{rms}	250 A gG
Temporary overvoltage (TOV) [L-N] (U_T) – Characteristic	440 V / 120 min. – withstand
Temporary overvoltage (TOV) [N-PE] (U_T) – Characteristic	1200 V / 200 ms – withstand
Let-through energy with an S20K275 ($I_{imp} = 2.5$ to 25 kA)	< 1 J
Operating temperature range [parallel] / [series] (T_U)	-40 °C ... +80 °C / -40 °C ... +60 °C
Operating state / fault indication	green / red
Number of ports	1
Cross-sectional area (L1, L2, L3, N, PE, \varnothing) (min.)	10 mm ² solid / flexible
Cross-sectional area (L1, L2, L3, N, PE, \varnothing) (max.)	35 mm ² stranded / 25 mm ² flexible
For mounting on	35 mm DIN rails acc. to EN 60715
Place of installation / Degree of protection	indoors / IP 20
Capacity	4 module(s), DIN 43880
Approvals	VDE, KEMA, UL
Type of remote signalling contact	yes / changeover contact
Switching capacity (a.c.)	250 V / 0.5 A
Switching capacity (d.c.)	250 V / 0.1 A; 125 V / 0.2 A; 75 V / 0.5 A
Cross-sectional area for remote signalling terminals	max. 1.5 mm ² solid / flexible
Extended technical data:	-----
Voltage protection level [L-PE] (U_p)	1.8 kV
For use in switchgear installations with prospective short-circuit currents of more than 50 kA _{rms} (tested by the German VDE)	-----
– Max. prospective short-circuit current	100 kA _{rms} (220 kA _{peak})
– Limitation / Extinction of mains follow currents	up to 100 kA _{rms} (220 kA _{peak})
– Max. backup fuse (L) up to $I_k = 100$ kA _{rms}	250 A gG

Use for 16.7 Hz traction power supply systems

Type	DV M2 TT 255 FM
Part No.	954 315
– Test voltage AC (U_C)	266 V
– Nominal voltage (a.c.) (U_N)	230 / 400 V
– Nominal frequency (a.c.) (f_N)	16.7 Hz
– Max. backup fuse	160 A gG @ 16.7 Hz
Weight	537 g
Customs tariff number (Comb. Nomenclature EU)	85363090
GTIN	4013364400917
PU	1 pc(s)

DEHNcombo

DCB YPV 1500 FM (900 076)

- Applicable in PV systems in accordance with IEC 60364-7-712 / DIN VDE 0100-712
- Universally applicable in earthed and unearthed PV systems
- Prewired type 1 and type 2 combined lightning current and surge arrester for use in photovoltaic generator circuits
- Fault-resistant Y circuit prevents damage to the surge protective device in case of insulation faults in the generator circuit



Figure without obligation

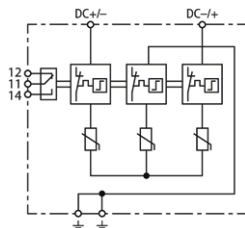

Basic circuit diagram DCB YPV 1500 FM

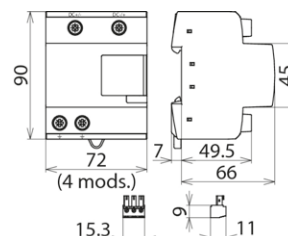

Dimension drawing DCB YPV 1500 FM

Combined lightning current and surge arrester for use in photovoltaic power supply systems up to 1500 V d.c.; with remote signalling contact.

Type Part No.	DCB YPV 1500 FM 900 076
SPD according to EN 61643-31 / IEC 61643-31	type 1 + type 2 / class I + class II
Max. PV voltage [DC+ -> DC-] (U_{CPV})	≤ 1500 V
Max. PV voltage [DC+/DC- -> PE] (U_{CPV})	≤ 1500 V
Short-circuit current rating (I_{SCPV})	10 kA
Nominal discharge current (8/20 μ s) (I_n)	20 kA
Max. discharge current (8/20 μ s) (I_{max})	40 kA
Total discharge current (8/20 μ s) [DC+/DC- -> PE] (I_{total})	40 kA
Total discharge current (10/350 μ s) [DC+/DC- -> PE] (I_{total})	12.5 kA
Lightning impulse current (10/350 μ s) [DC+ -> PE/DC- -> PE] (I_{imp})	6.25 kA
Voltage protection level [(DC+/DC-) -> PE] (U_p)	< 4.5 kV
Voltage protection level [DC+ -> DC-] (U_p)	< 4.5 kV
Response time (t_A)	≤ 25 ns
Operating temperature range (T_U)	-40 °C ... $+80$ °C
Operating state / fault indication	green / red
Number of ports	1
Cross-sectional area (min.)	1.5 mm ² solid / flexible
Cross-sectional area (max.)	35 mm ² stranded / 25 mm ² flexible
For mounting on	35 mm DIN rails acc. to EN 60715
Enclosure material	thermoplastic, red, UL 94 V-0
Place of installation	indoor installation
Degree of protection	IP 20
Dimensions	4 module(s), DIN 43880
Approvals	KEMA, UL
Type of remote signalling contact	changeover contact
Switching capacity (a.c.)	250 V / 0.5 A
Switching capacity (d.c.)	250 V / 0.1 A; 125 V / 0.2 A; 75 V / 0.5 A
Cross-sectional area for remote signalling terminals	max. 1.5 mm ² solid / flexible
Extended technical data:	-----
- Use in DC battery storage systems up to I_{SCCR}	≤ 50 kA ($t \leq 4$ ms)
- Backup fuse for DC battery storage systems up to I_{SCCR}	Bussman HLS 2000Vdc / 200 A 2+/A173 DST aR, manufacturer's Part No.: 170M2040
Weight	564 g
Customs tariff number (Comb. Nomenclature EU)	85354000
GTIN	6942299504552
PU	1 pc(s)

DEHNguard

DG M TT 275 FM (952 315)

- Prewired complete unit consisting of a base part and plug-in protection modules
- High discharge capacity due to heavy-duty zinc oxide varistors / spark gaps
- High reliability due to "Thermo Dynamic Control" SPD monitoring device



Figure without obligation

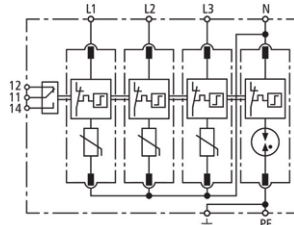

Basic circuit diagram DG M TT 275 FM

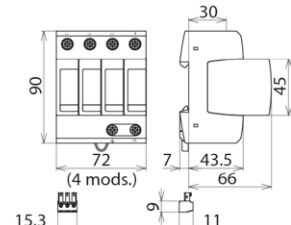

Dimension drawing DG M TT 275 FM

Modular surge arrester for use in TT and TN-S systems (3+1 configuration); with floating remote signalling contact.

Type	DG M TT 275 FM
Part No.	952 315
SPD according to EN 61643-11 / IEC 61643-11	type 2 / class II
Energy coordination with terminal equipment (≤ 10 m)	type 2 + type 3
Nominal voltage (a.c.) (U_N)	230 / 400 V (50 / 60 Hz)
Max. continuous operating voltage (a.c.) [L-N] (U_C)	275 V (50 / 60 Hz)
Max. continuous operating voltage (a.c.) [N-PE] (U_C)	255 V (50 / 60 Hz)
Nominal discharge current (8/20 μ s) (I_n)	20 kA
Max. discharge current (8/20 μ s) (I_{max})	40 kA
Voltage protection level [L-N]/[N-PE] (U_p)	≤ 1.5 / ≤ 1.5 kV
Voltage protection level [L-N] / [N-PE] at 5 kA (U_p)	≤ 1 / ≤ 1.5 kV
Follow current extinguishing capability [N-PE] (I_f)	100 A_{rms}
Response time [L-N] (t_A)	≤ 25 ns
Response time [N-PE] (t_A)	≤ 100 ns
Max. mains-side overcurrent protection	125 A gG
Short-circuit withstand capability for max. mains-side overcurrent protection (I_{SCCR})	50 kA_{rms}
Temporary overvoltage (TOV) [L-N] (U_T) – Characteristic	335 V / 5 sec. – withstand
Temporary overvoltage (TOV) [L-N] (U_T) – Characteristic	440 V / 120 min. – safe failure
Temporary overvoltage (TOV) [N-PE] (U_T) – Characteristic	1200 V / 200 ms – withstand
Operating temperature range (T_U)	-40 °C ... +80 °C
Operating state / fault indication	green / red
Number of ports	1
Cross-sectional area (min.)	1.5 mm ² solid / flexible
Cross-sectional area (max.)	35 mm ² stranded / 25 mm ² flexible
For mounting on	35 mm DIN rails acc. to EN 60715
Enclosure material	thermoplastic, red, UL 94 V-0
Place of installation	indoor installation
Degree of protection	IP 20
Capacity	4 module(s), DIN 43880
Approvals	KEMA, VDE, UL
Type of remote signalling contact	changeover contact
Switching capacity (a.c.)	250 V / 0.5 A
Switching capacity (d.c.)	250 V / 0.1 A; 125 V / 0.2 A; 75 V / 0.5 A
Cross-sectional area for remote signalling terminals	max. 1.5 mm ² solid / flexible
Extended technical data:	-----
Lightning impulse current (10/350 μ s) [N-PE] (I_{imp})	12 kA
Voltage protection level [L-PE] (U_p)	1.5 kV
Weight	415 g
Customs tariff number (Comb. Nomenclature EU)	85363030
GTIN	4013364108486
PU	1 pc(s)

DEHNguard

DG SE DC 900 FM (972 145)

- Universal single-pole surge arrester consisting of a base part and a plug-in protection module
- Powerful d.c. switching device DCD
- Can be used without additional backup fuse



Figure without obligation

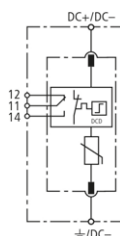

Basic circuit diagram DG SE DC 900 FM

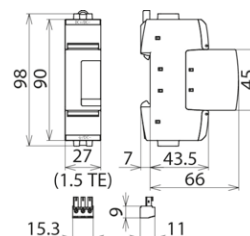

Dimension drawing DG SE DC 900 FM

Modular single-pole surge arrester for d.c. applications; with floating remote signalling contact.

Type	DG SE DC 900 FM
Part No.	972 145
SPD according to EN 61643-11 / IEC 61643-11	type 2 / class II
Energy coordination with terminal equipment (≤ 10 m)	type 2 + type 3
Nominal voltage (d.c.) (U_N)	750 V
Max. continuous operating voltage (d.c.) (U_C)	900 V
Nominal discharge current (8/20 μ s) (I_n)	12.5 kA
Voltage protection level (U_P)	≤ 3.0 kV
Response time (t_A)	≤ 25 ns
Short-circuit withstand capability without backup fuse (d.c.) (I_{SCCR})	100 A
Short-circuit withstand capability for max. mains-side overcurrent protection (d.c.) (I_{SCCR})	25 kA
Max. mains-side overcurrent protection	80 A gPV
Temporary overvoltage (TOV) d.c. (U_T) - Characteristic	1089 V / 5 sec. – withstand
Temporary overvoltage (TOV) d.c., $2 \times U_C$ (U_T) - Characteristic	1800 V / 120 min. – safe failure
Operating temperature range (T_U)	-40 °C ... +80 °C
Operating state / fault indication	green / red
Number of ports	1
Cross-sectional area (min.)	1.5 mm ² solid / flexible
Cross-sectional area (max.)	35 mm ² stranded / 25 mm ² flexible
For mounting on	35 mm DIN rails acc. to EN 60715
Enclosure material	thermoplastic, red, UL 94 V-0
Place of installation	indoor installation
Degree of protection	IP20
Capacity	1.5 module(s), DIN 43880
Type of remote signalling contact	changeover contact
Switching capacity (a.c.)	250 V / 0.5 A
Switching capacity (d.c.)	250 V / 0.1 A; 125 V / 0.2 A; 75 V / 0.5 A
Cross-sectional area for remote signalling terminals	max. 1.5 mm ² solid / flexible
Extended technical data:	use for safety lighting systems
– d.c. and a.c. operation	no
Weight	172 g
Customs tariff number (Comb. Nomenclature EU)	85363030
GTIN	4013364158658
PU	1 pc(s)

DEHNguard YPV

DG M YPV 1500 FM (952 567)

- High discharge capacity due to powerful zinc oxide varistors
- Modular prewired complete unit for use in photovoltaic systems consisting of a base part and plug-in protection modules
- Tried and tested fault-resistant Y circuit



Figure without obligation

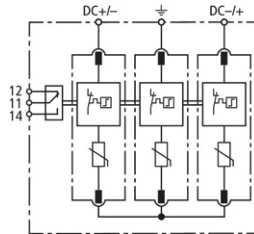

Basic circuit diagram DG M YPV 1500 FM

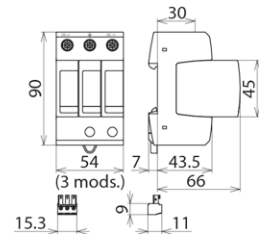

Dimension drawing DG M YPV 1500 FM

Multipole modular surge arrester for use in PV systems; with remote signalling contact for monitoring unit (floating changeover contact).

Type	DG M YPV 1500 FM
Part No.	952 567
SPD according to EN 61643-31 / IEC 61643-31	type 2 / class II
Max. PV voltage (U_{CPV})	1500 V
Short-circuit current rating (I_{SCPV})	10 kA
Total discharge current (8/20 μ s) (I_{total})	40 kA
Nominal discharge current (8/20 μ s) [(DC+/DC-) --> PE] (I_n)	15 kA
Max. discharge current (8/20 μ s) [(DC+/DC-) --> PE] (I_{max})	40 kA
Voltage protection level (U_p)	≤ 5 kV
Response time (t_A)	≤ 25 ns
Operating temperature range (T_U)	-40 °C ... +80 °C
Operating state / fault indication	green / red
Number of ports	1
Cross-sectional area (min.)	1.5 mm ² solid / flexible
Cross-sectional area (max.)	35 mm ² stranded / 25 mm ² flexible
For mounting on	35 mm DIN rails acc. to EN 60715
Enclosure material	thermoplastic, red, UL 94 V-0
Place of installation	indoor installation
Degree of protection	IP 20
Capacity	3 module(s), DIN 43880
Approvals	UL, KEMA
Type of remote signalling contact	changeover contact
Switching capacity (a.c.)	250 V / 0.5 A
Switching capacity (d.c.)	250 V / 0.1 A; 125 V / 0.2 A; 75 V / 0.5 A
Cross-sectional area for remote signalling terminals	max. 1.5 mm ² solid / flexible
Extended technical data:	-----
- Use in DC battery storage systems up to I_{SCCR}	≤ 50 kA ($t \leq 4$ ms)
- Backup fuse for DC battery storage systems up to I_{SCCR}	Bussman HLS 2000Vdc / 200 A 2+/A173 DST aR, manufacturer's Part No.: 170M2040
Weight	329 g
Customs tariff number (Comb. Nomenclature EU)	85363030
GTIN	4013364327726
PU	1 pc(s)

DEHNcord

DCOR L 2P 275 SO IP (900 448)

- Visual fault indication
- Interruption of the load circuit in the event of a fault
- Compact design



Figure without obligation

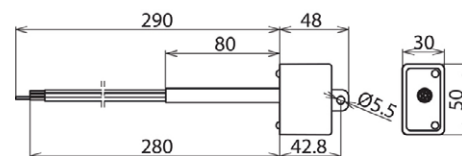
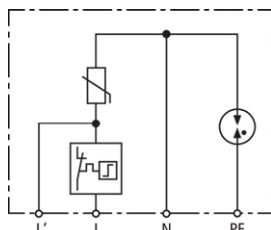

Dimension drawing DCOR L 2P 275 SO IP

Two-pole arrester for all installation systems; compact design. IP 65 degree of protection. With disconnection of the load circuit in the event of a fault.

Technical data

Type	DCOR L 2P 275 SO IP
Part No.	900 448
SPD according to EN 61643-11 / IEC 61643-11	type 2 / class II
Energy coordination with terminal equipment (≤ 10 m)	type 2 + type 3
Nominal voltage (a.c.) (U_N)	230 V (50 / 60 Hz)
Max. continuous operating voltage (a.c.) [L-N] (U_C)	275 V (50 / 60 Hz)
Max. continuous operating voltage (a.c.) [N-PE] (U_C)	255 V (50 / 60 Hz)
Nominal discharge current (8/20 μ s) (I_n)	5 kA
Max. discharge current (8/20 μ s) (I_{max})	10 kA
Voltage protection level [L-N] (U_p)	≤ 1.5 kV
Voltage protection level [L-N] at 3 kA (U_p)	≤ 1 kV
Voltage protection level [L-N] at 1.5 kA (U_p)	≤ 0.85 kV
Voltage protection level [N-PE] (U_p)	≤ 1.5 kV
Follow current extinguishing capability [N-PE] (I_f)	100 A _{rms}
Response time [L-N] (t_A)	≤ 25 ns
Response time [L/N-PE] (t_A)	≤ 100 ns
Max. load current (I_L)	10 A
Max. mains-side overcurrent protection	B 16 A
Short-circuit withstand capability for mains-side overcurrent protection (I_{SCCR})	1 kA _{rms}
Short-circuit withstand capability for mains-side overcurrent protection with 16 A gG (I_{SCCR})	6 kA _{rms}
Temporary overvoltage (TOV) [L-N] (U_T) – Characteristic	335 V / 5 sec. – withstand
Temporary overvoltage (TOV) [L-N] (U_T) – Characteristic	440 V / 120 min. – safe failure
Temporary overvoltage (TOV) [N-PE] (U_T) – Characteristic	1200 V / 200 ms – safe failure
Fault indication	red
Interruption of the load circuit in the event of a fault	yes
Number of ports	1
Operating temperature range (T_U)	-40 °C ... +80 °C
Connecting cable	1.5 mm ² , 230 mm long
Enclosure material	thermoplastic, red, UL 94 V-2
Degree of protection of installed device	IP 65
Additional tests:	-----
– Total discharge current (I_{sum})	20 kA
Extended technical data:	-----
– Combination wave (U_{oc})	10 kV
Weight	113 g
Customs tariff number (Comb. Nomenclature EU)	85363030
GTIN	4013364293007
PU	1 pc(s)

DEHNrecord

DRC IRCM (910 710)

- Condition monitoring of BLITZDUCTORconnect arresters with integrated LifeCheck
- Quick and simple installation and initial operation (without addressing arresters)
- Remote signalling via floating remote signalling contact (break contact)



Figure without obligation

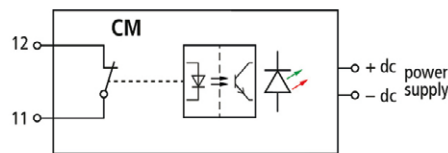

Basic circuit diagram DRC IRCM

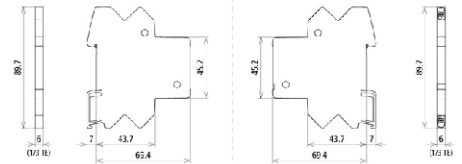

Dimension drawing DRC IRCM

Condition monitoring unit DEHNrecord, set for DIN rail mounted devices with integrated visual transmitter/receiver and visual reverse unit for monitoring the condition of BLITZDUCTORconnect arresters with LifeCheck. Visual status indication via LED group display in combination with remote signalling contact (break contact).

Type	DRC IRCM
Part No.	910 710
Input voltage range (d.c.) (U_{IN})	6-35 V d.c.
Max. rated current consumption (I_{IN})	≤ 10 mA
Distance between transmitter / receiver and reverse unit	≤ 305 mm
Message: Replacing of SPD recommended	LED, remote signalling contact (break contact)
Indicator	two-colour LED (green, red)
Type of remote signalling contact	break contact (nc)
Technical data of remote signalling contact	contact resistance < 2.5 ohms; leakage current < 1 μ A
Switching capacity (d.c.)	48 V / 500 mA / Pmax 300 mW
Test cycle	continuous
Operating temperature range (T_U)	-30 °C ... +70 °C
Degree of protection	IP 20
For mounting on	35 mm DIN rails acc. to EN 60715
Connection (input / output)	Push-in / Push-in
Cross-sectional area (solid)	0.2-2.5 mm ²
Cross-sectional area (flexible)	0.2-2.5 mm ²
Enclosure material	polyamide PA 6.6
Colour	grey
Test standards	EN 61010-1
Approvals	UL
Delivery includes	Transmitter-/receiver unit /reverse unit
Weight	52 g
Customs tariff number (Comb. Nomenclature EU)	90308900
GTIN	4013364424678
PU	1 pc(s)

BLITZDUCTOR

BCO ML2 B 180 (927 210)

- LifeCheck arrester monitoring and integrated status indication
- Modular two-pole arrester for lightning equipotential bonding
- For installation in conformity with the lightning protection zone concept at the boundaries from $0_A -1$ and higher



Figure without obligation

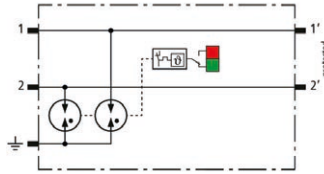

Basic circuit diagram BCO ML2 B 180

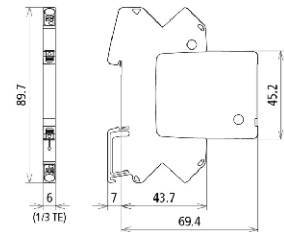

Dimension drawing BCO ML2 B 180

Space-saving, modular lightning current arrester with a width of 6 mm and push-in connection technology with status indication for protecting two single lines for lightning equipotential bonding as well as indirect earthing of shielded cables. With signal disconnection for maintenance purposes.

Type	BCO ML2 B 180
Part No.	927 210
SPD class	TYPE 1
Impulse category	D1, C2, C3
Nominal voltage (U_N)	180 V
Max. continuous operating voltage (d.c.) (U_C)	180 V
Max. continuous operating voltage (a.c.) (U_C)	127 V
Nominal current (I_L)	1.2 A
D1 Total lightning impulse current (10/350 μ s) (I_{imp})	3 kA
D1 Lightning impulse current (10/350 μ s) per line (I_{imp})	1.5 kA
C2 Total nominal discharge current (8/20 μ s) (I_n)	10 kA
C2 Nominal discharge current (8/20 μ s) per line (I_n)	5 kA
Voltage protection level line-line for I_n C2 (U_p)	≤ 1100 V
Voltage protection level line-PG for I_n C2 (U_p)	≤ 800 V
Voltage protection level line-line at 1 kV/ μ s C3 (U_p)	≤ 950 V
Voltage protection level line-PG at 1 kV/ μ s C3 (U_p)	≤ 700 V
Series resistance per line	0 ohm(s)
Cut-off frequency line-line at 100 ohms (f_c)	150 MHz
Operating temperature range (T_U)	-40 °C ... +80 °C
Operating state / fault indication	green / red
Degree of protection	IP 20
Connection (input / output)	push-in / push-in
Cross-sectional area (solid)	0.2-2.5 mm ²
Cross-sectional area (flexible)	0.2-2.5 mm ²
Earthing via	35 mm DIN rails acc. to EN 60715
Enclosure material	polyamide PA 6.6
Colour	yellow
Test standards	IEC 61643-21 / EN 61643-21
Approvals	UL, CSA, EAC, ATEX, IECEx, CCC, SIL
ATEX approvals	TÜV 20 ATEX 8527 X: II 3G Ex ec IIC T4 Gc
IECEx approvals	IECEx TUR 20.0063X: Ex ec IIC T4 Gc
China Compulsory Certification	CCC no. 2021312304001192
Extended technical data:	-----
- Discharge current (8/20 μ s) [1/2 - PG], [1+2 - PG]	10 kA (10x)
- Voltage protection level line-PG at 1 kV/ μ s C3 after being subjected to I_{max} (U_p)	≤ 700 V
Weight	33 g
Customs tariff number (Comb. Nomenclature EU)	85363010
GTIN	4013364405585
PU	1 pc(s)

BLITZDUCTOR

BCO ML2 BD HF 24 (927 275)

- LifeCheck arrester monitoring and integrated status indication
- Modular two-pole arrester for optimal protection of one pair of high-frequency signal circuits
- For installation in conformity with the lightning protection zone concept at the boundaries from $0_A - 2$ and higher



Figure without obligation

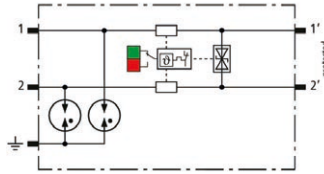

Basic circuit diagram BCO ML2 BD HF 24

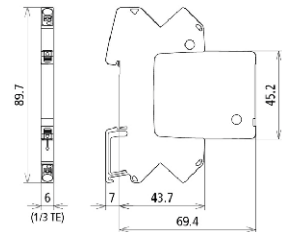

Dimension drawing BCO ML2 BD HF 24

Space-saving, modular combined arrester with a width of 6 mm and push-in connection technology with status indication for protecting one pair of unearthed high-frequency bus systems as well as balanced interfaces. With signal disconnection for maintenance purposes.

Type	BCO ML2 BD HF 24
Part No.	927 275
SPD class	TYPE 1 P2
Impulse category	D1, C1, C2, C3, B2
Nominal voltage (U_N)	24 V
Max. continuous operating voltage (d.c.) (U_C)	36 V
Max. continuous operating voltage (a.c.) (U_C)	25.4 V
Nominal current at 70 °C (I_L)	0.75 A
D1 Total lightning impulse current (10/350 μ s) (I_{imp})	3 kA
D1 Lightning impulse current (10/350 μ s) per line (I_{imp})	1.5 kA
C2 Total nominal discharge current (8/20 μ s) (I_n)	10 kA
C2 Nominal discharge current (8/20 μ s) per line (I_n)	5 kA
Voltage protection level line-line for I_n C2 (U_p)	≤ 85 V
Voltage protection level line-PG for I_n C2 (U_p)	≤ 650 V
Voltage protection level line-line for I_n C1 (U_p)	≤ 85 V
Voltage protection level line-PG for I_n C1 (U_p)	≤ 650 V
Voltage protection level line-line at 1 kV/ μ s C3 (U_p)	≤ 48 V
Voltage protection level line-PG at 1 kV/ μ s C3 (U_p)	≤ 600 V
Series resistance per line	1 ohm(s)
Cut-off frequency line-line (f_c)	100 MHz
Operating temperature range (T_U)	-40 °C ... +80 °C
Operating state / fault indication	green / red
Degree of protection	IP 20
Connection (input / output)	push-in / push-in
Cross-sectional area (solid)	0.2-2.5 mm ²
Cross-sectional area (flexible)	0.2-2.5 mm ²
Earthing via	35 mm DIN rails acc. to EN 60715
Enclosure material	polyamide PA 6.6
Colour	yellow
Test standards	IEC 61643-21 / EN 61643-21
Approvals	UL, EAC
Extended technical data:	-----
- Max. discharge current (8/20 μ s) [1/2 - PG], [1+2 - PG] (I_{max})	20 kA
- Discharge current (8/20 μ s) [1/2 - PG], [1+2 - PG]	10 kA (10x)
- Voltage protection level line-PG at 1 kV/ μ s C3 after being subjected to I_{max} (U_p)	≤ 600 V
Weight	34 g
Customs tariff number (Comb. Nomenclature EU)	85363010
GTIN	4013364468566
PU	1 pc(s)

DEHNgate

DGA G SMA (929 039)

- Compact dimensions
- Extremely wide transmission range
- For installation in conformity with the lightning protection zone concept at the boundaries from $0_B - 1$ and higher



Figure without obligation

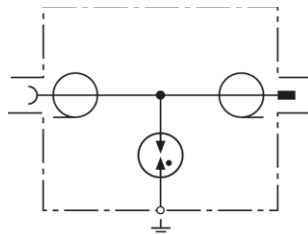

Basic circuit diagram DGA G SMA

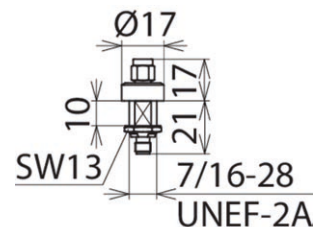

Dimension drawing DGA G SMA

Surge arrester for remote supply with integrated gas discharge tube. Ideally suited for wireless applications for the coaxial interfaces of devices and antennas.

Available with SMA, BNC or N connection for bushing installation.

Type	DGA G SMA
Part No.	929 039
SPD class	TYPE2
Max. continuous operating voltage (d.c.) (U_c)	135 V
Nominal current (I_n)	2 A
Max. transmission capacity	60 W
D1 Lightning impulse current (10/350 μ s) (I_{imp})	1 kA
C2 Nominal discharge current (8/20 μ s) (I_n)	5 kA
Voltage protection level for I_n C2 (U_p)	≤ 700 V
Frequency range	0-5.8 GHz
Insertion loss	≤ 0.2 dB
Return loss (d.c. - 3 GHz)	≥ 20 dB
Return loss (3 GHz-5.8 GHz)	≥ 18 dB
Characteristic impedance (Z)	50 ohms
Operating temperature range (T_u)	-40 °C ... +85 °C
Degree of protection (if lines are connected)	IP 65
Connection	SMA socket / SMA plug
Earthing via	bushing ($\varnothing 11.2$ mm)
Enclosure material	gold-plated brass
Colour	gold
Test standards	IEC 61643-21 / EN 61643-21
Weight	24 g
Customs tariff number (Comb. Nomenclature EU)	85366910
GTIN	4013364135185
PU	1 pc(s)

DEHNpatch

DPA CLE IP66 (929 221)

- Indoor / outdoor applications (IP 66)
- GBit Ethernet applications and structured cabling systems according to class E up to 250 MHz
- Power over Ethernet IEEE 802.3 (up to PoE++ / 4PPoE)
- For installation in conformity with the lightning protection zone concept at the boundaries from $0_B -2$ and higher



Figure without obligation

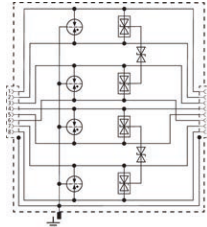

Basic circuit diagram DPA CLE IP66

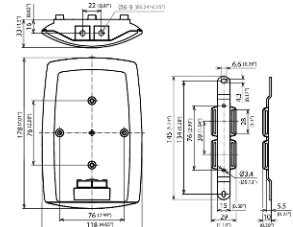

Dimension drawing DPA CLE IP66

Universal surge arrester for GBit Ethernet applications, Power over Ethernet (IEEE 802.3 compliant up to PoE++ / 4PPoE) and similar applications in structured cabling systems up to class E in indoor and outdoor areas in an IP66 rated enclosure impervious to dust and water. Protection of all pairs with gas discharge tubes and one adapted filter matrix for each pair. Fully shielded surge protective solution with RJ 45 sockets. Universal mounting bracket for pole and wall mounting.

External accessories: Tensioning straps for pole mounting

Type	DPA CLE IP66
Part No.	929 221
SPD class	TYPE 2 P1
Nominal voltage (U_N)	5 V
Max. continuous operating voltage d.c. line-line (U_C)	8.5 V
Max. continuous operating voltage (a.c.) (U_C)	6 V
Max. continuous operating voltage (d.c.) pair-pair (PoE) (U_C)	60 V
Nominal current (I_N)	1 A
D1 Lightning impulse current (10/350 μ s) per line (I_{imp})	0.8 kA
D1 Total lightning impulse current (10/350 μ s) (I_{imp})	4 kA
C2 Nominal discharge current (8/20 μ s) line-line (I_n)	400 A
C2 Nominal discharge current (8/20 μ s) line-PG (I_n)	2.5 kA
C2 Total nominal discharge current (8/20 μ s) (I_n)	10 kA
Voltage protection level line-line for I_n C2 (U_p)	≤ 170 V
Voltage protection level line-PG for I_n C2 (U_p)	≤ 600 V
Voltage protection level line-line for I_n C2 (PoE) (U_p)	≤ 120 V
Voltage protection level line-line at 1 kV/ μ s C3 (U_p)	≤ 180 V
Voltage protection level line-PG at 1 kV/ μ s C3 (U_p)	≤ 500 V
Voltage protection level pair-pair at 1 kV/ μ s C3 (PoE) (U_p)	≤ 120 V
Cut-off frequency (f_c)	250 MHz
Operating temperature range (T_U)	-40 °C ... +80 °C
Degree of protection (with installed cables)	IP 66
For mounting on	pole / wall
Connection (input / output)	RJ45 socket / RJ45 socket
Pinning	1/2, 3/6, 4/5, 7/8
Earthing via	enclosure with pole / wall bracket
Enclosure material	aluminium die-cast, nickel plated
Colour	bare surface
Test standards	IEC 61643-21 / EN 61643-21
Approvals	UL, CSA, EAC
External accessories	tensioning straps for pole mounting
Weight	606 g
Customs tariff number (Comb. Nomenclature EU)	85363010
GTIN	4013364342866
PU	1 pc(s)

HVI light Conductor inside of supporting tube with air-termination rod

HVI LI 20 L6M SR1990 FSP1000 GFK AL V2A (819 256)



Figure without obligation



Type	HVI LI 20 L6M SR1990 FSP1000 GFK AL V2A
Part No.	819 256
Material of supporting tube	GRP / Al
Length of supporting tube	1990 mm
Transport length	1990 mm
Material of air-termination tip	StSt
Length of air-termination tip	1000 mm
Diameter Ø conductor	20 mm
Colour of conductor	grey ●
Material of conductor	Cu
RAL colour	similar to 7000
Cross section of core	19 mm ²
Lightning current carrying capability (class / I _{imp})	H1 / 150 kA
Equivalent separation distance s (air)	≤ 45 cm
Material of insulation	PE
Material of sheath	PVC
Characteristics of sheath	UV stabilized and weather resistant
Connection diameter	10 mm
EB connection cable	strip StSt 1000 x 18 x 0.4 mm
Material of connection elements	StST
Minimum order length	6 m
Max. gust wind speed	198 km/h
Max. free length	2390 mm
Min. clamping length	600 mm
Standard	DIN IEC/TS 62561-8 (VDE V 0185-561-8)
Weight	6,03 kg
Customs tariff number (Comb. Nomenclature EU)	85389099
GTIN	4013364255388
PU	1 pc(s)

Air-termination rod

FS 10 1000 AL (101 000)



Figure without obligation

Air-termination rod chamfered on both sides, for protecting roof-mounted structures, chimneys etc., can be fixed in a concrete base (8.5 kg) with fixing wedge or by means of rod holders / spacers.

Type	FS 10 1000 AL
Part No.	101 000
Total length (l1)	1000 mm
Material	Al
Diameter Ø	10 mm
Standard	EN 62561-2
Weight	212 g
Customs tariff number (Comb. Nomenclature EU)	85389099
GTIN	4013364094505
PU	20 pc(s)

Equipotential busbar

PAS 11AK (563 200)



Figure without obligation

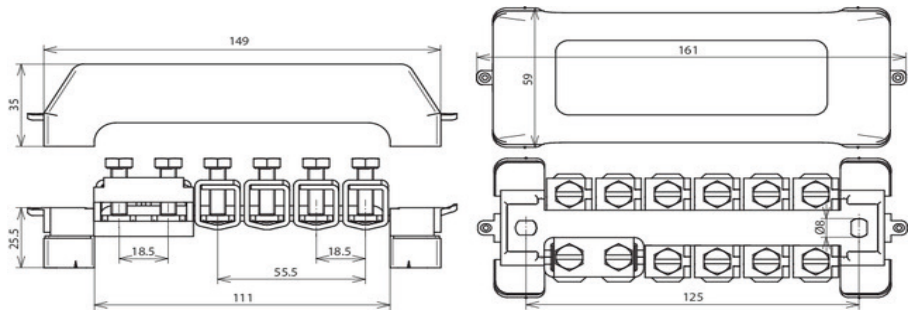

Arrangement:

Type	PAS 11AK
Part No.	563 200
Connection (solid / stranded)	10 x 2.5-95 mm ²
Connection Rd	or 10 x -10 mm
Connection FI	1 x -30 x 4 mm
Material of cage clamp	St/tZn
Material of contact rail	Cu/gal Sn
Cross section	30 mm ²
Fixing	[2x] 6 x 8 mm
Fixing frames	P (grey)
Cover	P (grey/sealable)
Lightning current carrying capability (10/350 µs)	100 kA / 50 kA ^{*)}
Standard	EN 62561-1
Type	halogen-free
Weight	410 g
Customs tariff number (Comb. Nomenclature EU)	85389099
GTIN	4013364056558
PU	1 pc(s)

*) For exact assignment, see test certificate.

Connection lug with clamping frame

 **AL ZF KB 6.10STTZN B5.2 6.5 L81 AL (377 100)**



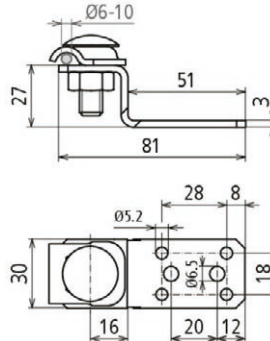

Figure without obligation



Arrangement:



Type	AL ZF KB 6.10STTZN B5.2 6.5 L81 AL
Part No.	377 100
Material of bracket	Al
Material thickness (t1)	3 mm
Fixing	[4x] $\varnothing 5.2$ / [2x] $\varnothing 6.5$ mm
Fixing possibility	blind rivets or drilling screws
Application note	according to EN 62305-3 Suppl. 1 4 rivets $\varnothing 5$ mm, 2 rivets $\varnothing 6$ mm shall be used to connect materials ≥ 0.5 mm thick or 2 Parker screws StSt $\varnothing 6.3$ mm for materials ≥ 2 mm thick.
Material of clamping piece	St/tZn
Screw	 M10 x 30 mm
Material of screw / nut	StSt
Connection	lengthwise / crosswise
Connection with	clamping piece
Clamping range Rd	6-10 mm
Lightning current carrying capability (10/350 μ s)	 ^{*)}
Standard	EN 62561-1
Weight	74 g
Customs tariff number (Comb. Nomenclature EU)	85389099
GTIN	4013364078604
PU	50 pc(s)

*) For exact assignment, see test certificate.

Round wire



RD 10 V4A R80M (860 010)

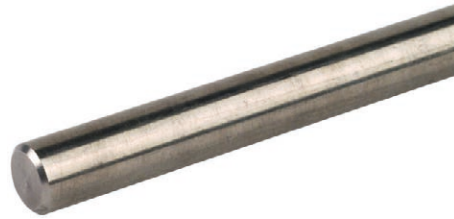

Figure without obligation

Stainless steel wire according to EN 62561-2, for lightning protection and earth-termination systems or equipotential bonding.

Stainless steel wires for use in soil have to be made of StSt (V4A) with a molybdenum content $> 2\%$ e.g. 1.4571, 1.4404, in accordance with EN 62561-2 and IEC/EN 62305-3.

Type	RD 10 V4A R80M
Part No.	860 010 ✓
Diameter Ø conductor	10 mm
Cross-section	78 mm ²
Material	StSt (V4A)
Material No.	1.4571 / 1.4404
ASTM / AISI:	316Ti / 316L
Standard	based on EN 62561-2
Conductivity	$\geq 1.25 \text{ m} / \text{Ohm mm}^2$
Resistivity	$\leq 0.8 \text{ Ohm mm}^2 / \text{m}$
Short-circuit current (a.c. 50 Hz / d.c.) (1 s; $\leq 300 \text{ }^\circ\text{C}$)	2.9 kA
Weight	617 g/m
Customs tariff number (Comb. Nomenclature EU)	72210010
GTIN	4013364019997
PU	80 m

Strip



BA 30X3.5 V2A R60M (860 900)



Figure without obligation

Stainless steel strip according to EN 62561-2, for lightning protection systems and ring equipotential bonding.

Type	BA 30X3.5 V2A R60M
Part No.	860 900 ✓
Width	30 mm
Thickness	3.5 mm
Cross-section	105 mm ²
Material	StSt
Material No.	1.4301 / 1.4303
Standard	EN 62561-2
Conductivity	$\geq 1.25 \text{ m} / \text{Ohm mm}^2$
Resistivity	$\leq 0.8 \text{ Ohm mm}^2 / \text{m}$
Short-circuit current (a.c. 50 Hz / d.c.) (1 s; $\leq 300 \text{ }^\circ\text{C}$)	3.9 kA
Weight	824 g/m
Customs tariff number (Comb. Nomenclature EU)	72202021
GTIN	4013364143395
PU	60 m

Surge Protection
Lightning Protection
Safety Equipment
DEHN protects.

DEHN SE
Hans-Dehn-Str. 1
Postfach 1640
92306 Neumarkt, Germany

Tel. +49 9181 906-0
Fax +49 9181 906-1100
info@dehn.de
www.dehn-international.com



www.dehn-international.com/partners

Type designations of products mentioned in this white paper which are at the same time registered trademarks are not especially marked. Hence the absence of TM or © markings does not indicate that the type designation is a free trade name. Nor can it be seen whether patents or utility models and other intellectual and industrial property rights exist. We reserve the right to introduce changes in performance, configuration and technology, dimensions, weights and materials in the course of technical progress. The figures are shown without obligation. Misprints, errors and modifications excepted. Reproduction in any form whatsoever is forbidden without our authorisation.